

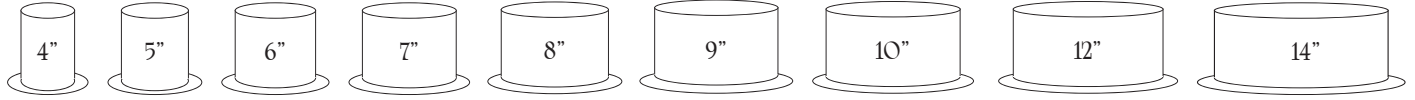

Cake servings depend on how large you cut the pieces. Cake servings listed are based on 1" x 2" slices. Our cakes average 5" - 6" tall. Tiered cakes average 4.5" - 5.5" tall per tier. All cakes are 3 layers of cake with buttercream filled layers.

This guide will help decide the best size to order. Things to consider, do you have guests with small or large appetites? Do you want left overs?



Note: only available on tiered cakes. 4" is not available for purchase as an individual custom cake.



4-8 servings

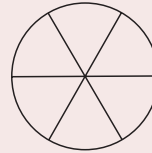

← Cut me like this

Great for our smallest tiered cake 6", 4", or on top of a 3 tiered cake!



up to 8 servings

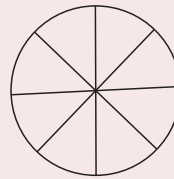

← Cut me like this

Great for smash cakes or small single family gatherings



up to 12 servings

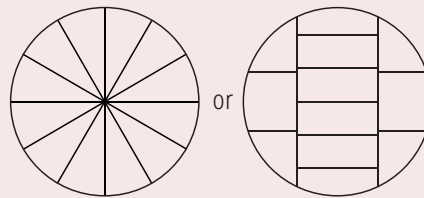

← Cut me like this

Our most popular size!



up to 18 servings

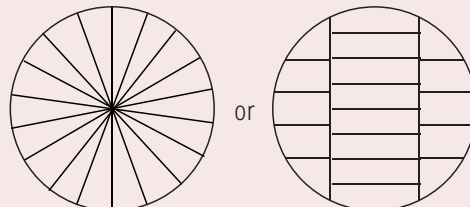

← Cut me like this

Great for parties and tiered cakes

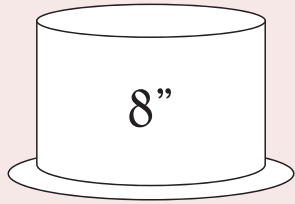

up to
24 servings

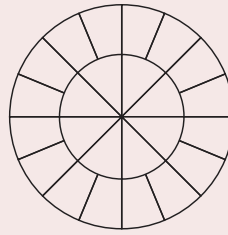

or

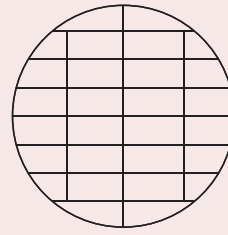

← Cut me
like this

Great for parties and tiered cakes

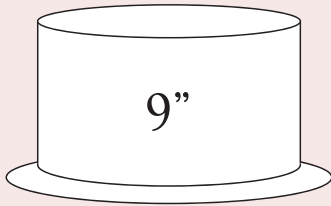

up to
32 servings

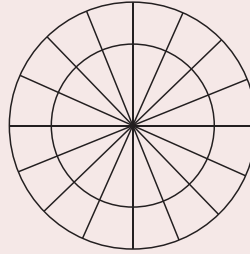

or

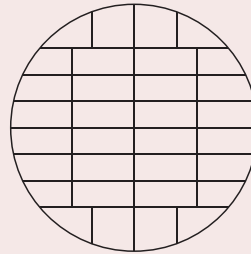

← Cut me
like this

Great for tiered cakes

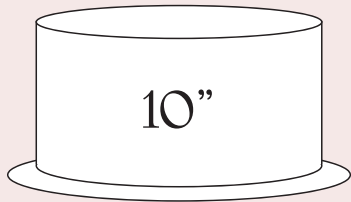

up to
38 servings

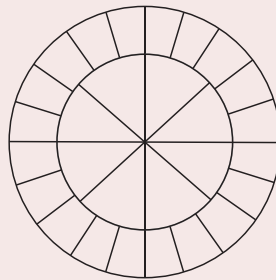

or

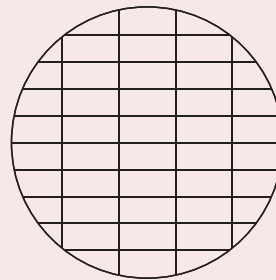

← Cut me
like this

Great for tiered cakes

Available for large tiered cakes



up to
56
servings



up to
78
servings

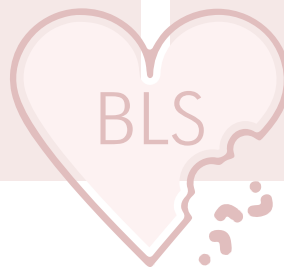



tiered cake sizes...

up to 18 servings

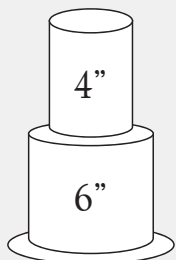

up to 26 servings

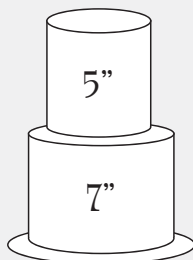

up to 36 servings

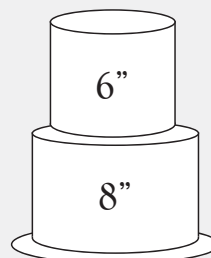

up to 50 servings

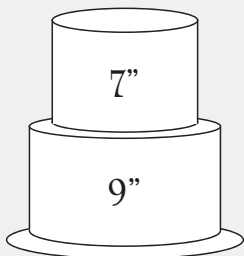

up to 62 servings

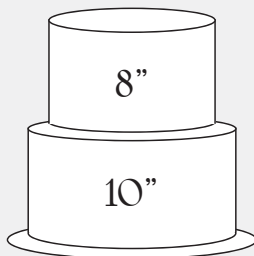

up to 94 servings



up to 134 servings

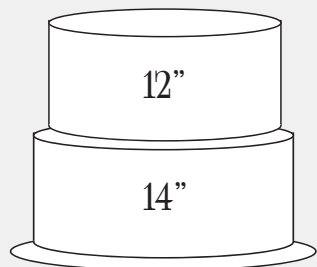

up to 42 servings

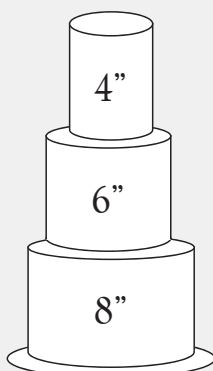

up to 58 servings

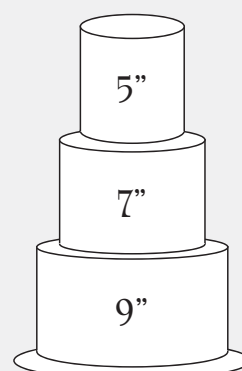

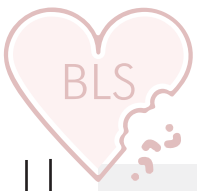

tiered cake sizes...

up to 74 servings

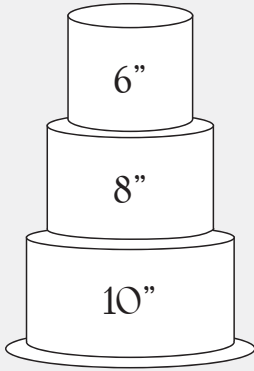

up to 118 servings

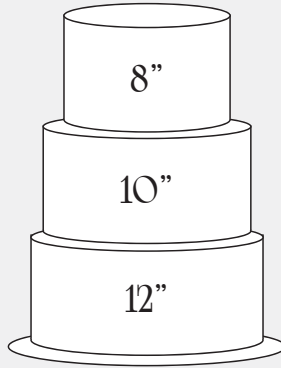

up to 172 servings

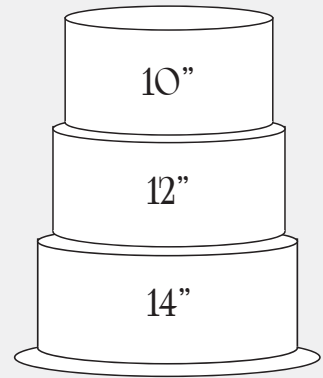

serves up to 80

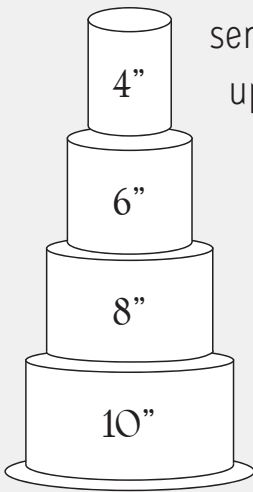

serves up to 130

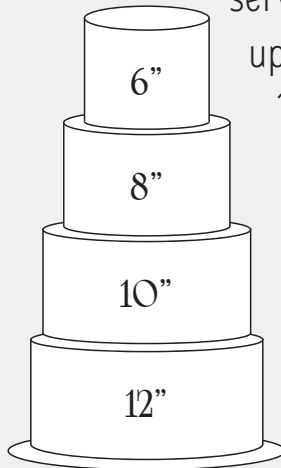

serves up to 196

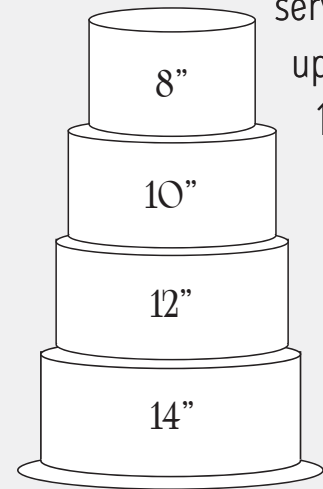

serves up to 138

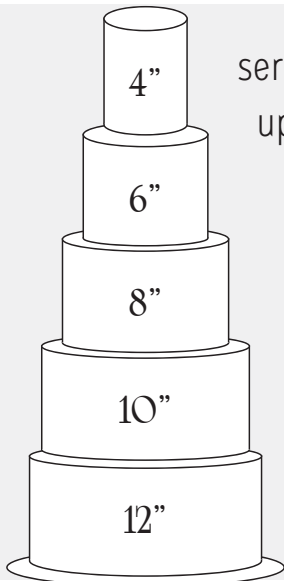

serves up to 208

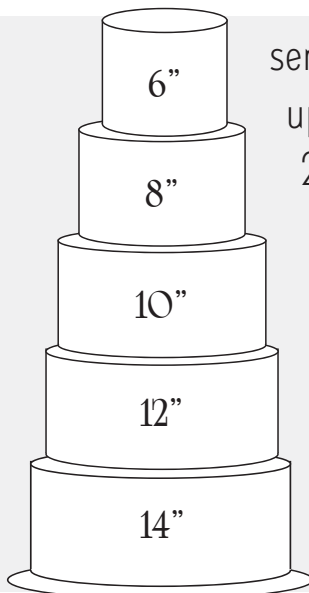

- 403.462.2806
- monique@blsyc.com
- [butter_love_sugar](#)
- [@butter_love_sugar](#)